

Ref. 1500 | GU-10



Linha: Flow
Família: Pendente
Descrição: Pendente Accord Flow 1500

Material: Lâmina natural de madeira, MDF e aço carbono.

8X GU10-MR11 (max. 5W cada) LED, lâmpada não inclusa

Temperatura de Cor: De acordo com a lâmpada
CRI: De acordo com a lâmpada
Fluxo Luminoso: De acordo com a lâmpada
Potência Total: De acordo com a lâmpada

Tensão de Entrada: 127V - 220V
Frequência de Entrada: 60 Hz
Isolamento: Classe II

Limite Ajuste de Altura: 160cm/63in

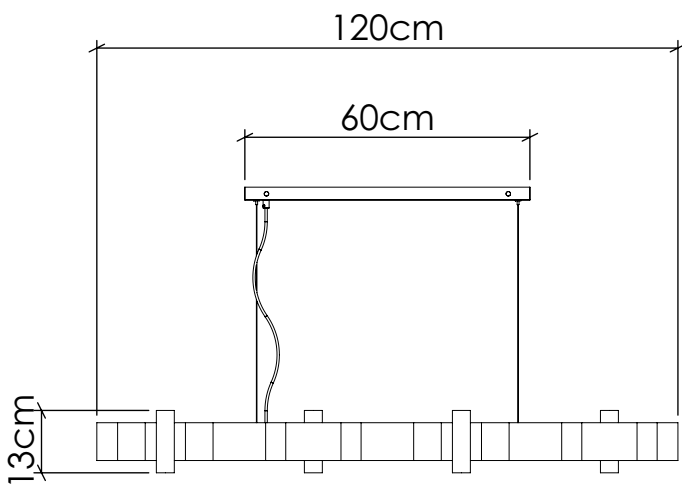

OPÇÕES DE ACABAMENTO



06
IMBUÍIA



09
LOURO FREIJÓ



12
TECA

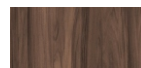

18
NOGUEIRA



34
MAPLE



43
FREIJÓ CATEDRAL



44
CARVÃO



45
ASH

