

F1050

Linha: Cilíndrica
Família: Mesa de apoio
Descrição: Mesa Accord Balance F1050

Material: Lâmina Natural de Madeira, MDF e Aço Carbono.

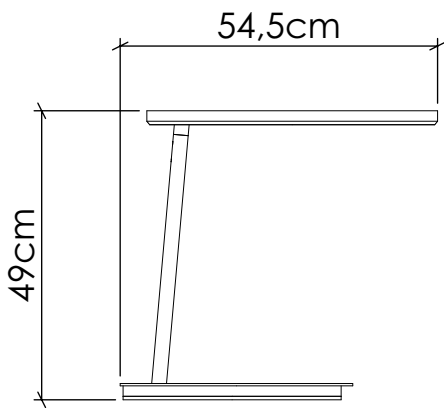

OPÇÕES DE ACABAMENTO



06
IMBUÍA



12
TECA



34
MAPLE



45
ASH



09
LOURO FREIJÓ



18
NOGUEIRA



44
CARVÃO

