



Specifier: _____ Date: _____

Project name: _____

Project location: _____

1520 [GU10]

Name: Harmony Accord Pendant 1520
 Collection: Harmony
 Application: Pendant
 Construction: Natural Wood Veneer, MDF

Fixture Image



Specifications

Light Source: 1x 8w 120v - 240v [Gu10]
 Driver Location: N/A
 Color Temperature: Lamp Dependent
 Dimming Option: Lamp Dependent
 CRI: Lamp Dependent
 Delivered Lumens: Lamp Dependent
 Total Power: Lamp Dependent
 Input Voltage: 120V-240V
 Input Frequency: 60 Hz
 Height Adjustment Limit: 10'
 Lamp Type: Gu10 MR16

Technical Drawing

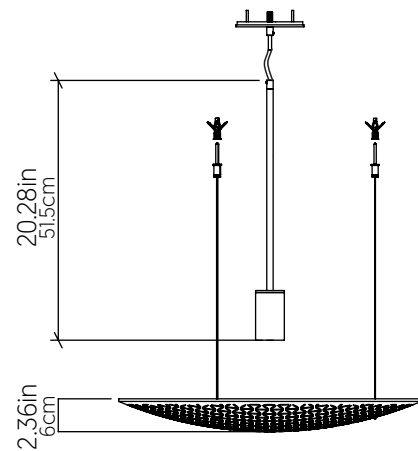

Photometric Graph

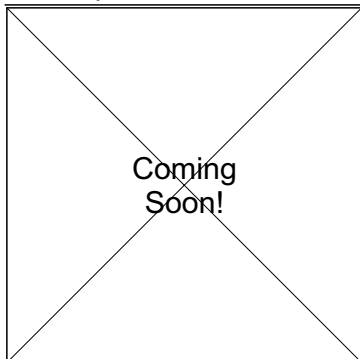

Standards

