

F1025

H02

ASSEMBLING, USE AND CONSERVATION INSTRUCTIONS - USA & CANADA

COLLECTION: Cascade
APPLICATION: Coffee Table
DESCRIPTION: Accord Cascade Coffee Table F1025
MATERIALS: Natural wood veneer, MDF, carbon steel.

Read carefully all the instructions for the removal of the package and for the correct assembling, use and application:

ASSEMBLING THE TABLE

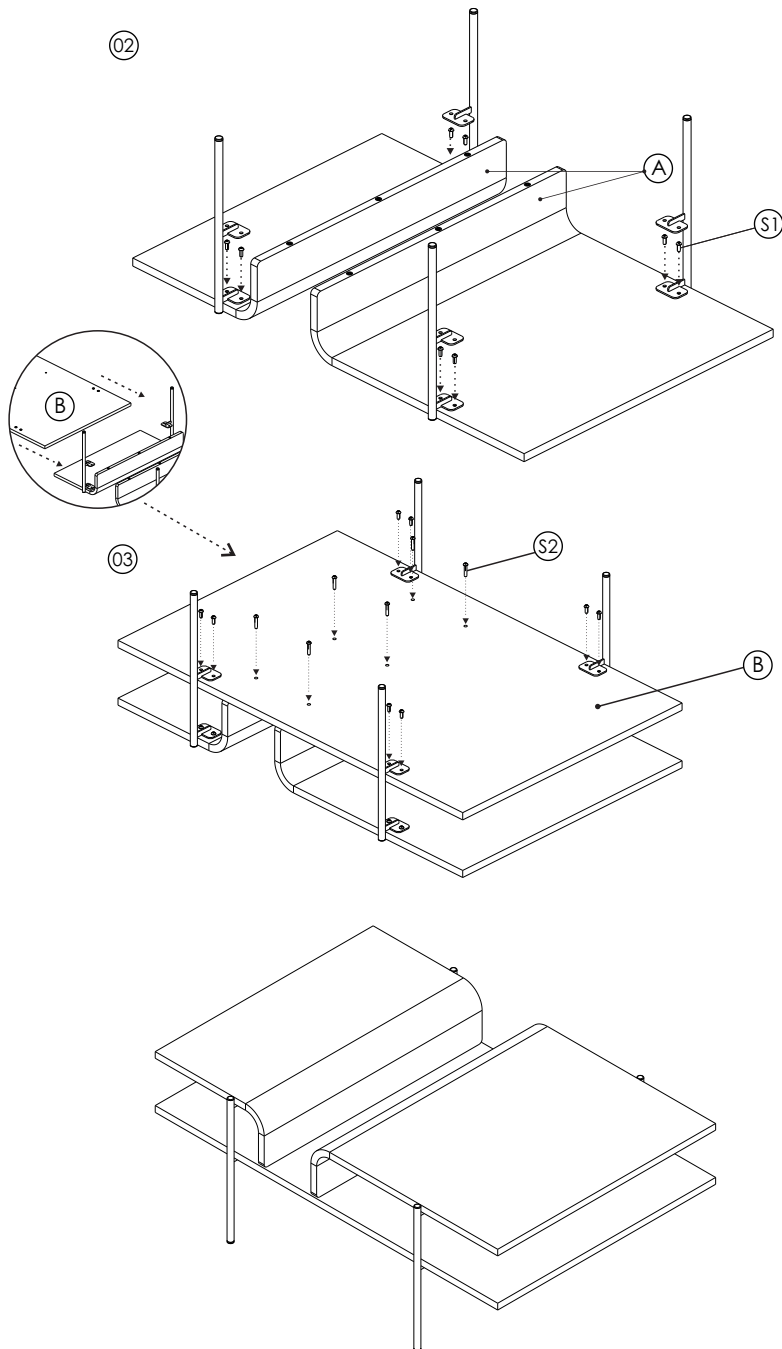

- 01 Remove the protecting package taking care to not scratch or cut the product. Place the curved parts of the table in a flat and clean surface to avoid scratches in the natural wood during the assembling process.
- 02 With the curved tops (A) of the table pointing upwards, start the alignment of the metal rods with the holes in the tops; Use the provided screws (S1) and the 4mm allen wrench to secure the fixation the top with the metal rods.
- 03 Then, insert the base (B) between the metallic rods, following the instructions as shown in the diagram. Place them in a way where the holes of the far end of the curved lids (A) are aligned with the holes in the middle of the (B), then, proceed the fixation using the screws (S2). After finishing this step, fasten the metal rods in the base with the (S1) screws;

Your table is ready for use!

USER GUIDE

The table was designed to indoor ambients, it should not be exposed to the elements, like direct sunlight, humidity, sea air or extreme weather conditions.

Avoid placing glasses, bottles and other containers that are too hot, cold or wet on the table, in order to avoid permanent stains on the natural wood veneer.

The table must be cleaned using only a cloth slightly moistened with water and neutral soap, avoiding any abrasive cleaning product.

WARNING!
FAILURE TO COMPLY WITH THESE INSTRUCTIONS MAY
CAUSE ACCIDENTS AND LOSS OF PRODUCT WARRANTY.
THE TABLE MUST NOT BE USED AS A SUPPORT SURFACE
TO CLIMB OR SIT IN

PROVIDED SCREWS

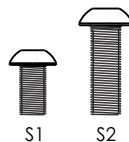

SAVE THESE INSTRUCTIONS FOR FUTURE REFERENCE.

Accord Home guarantees coverage against manufacturing defects including finishes, for a period of three months, under normal use from the date of purchase. For warranty service, please contact your local dealer for further instructions. Proof of date of purchase will be required for validation of warranty service.

The responsibility of the manufacturer regarding the product warranty is related to the correct observation of the instructions contained in this manual. The manufacturer is not responsible for any damage to the product caused by accidents, alterations of any kind, improper usage or improper installation. See the website for additional warranty details.

Accord Home reserves the right to change the dimensions and specifications contained in this manual without prior notice, in accordance with its policy of continuous product improvement. Please, contact the manufacturer if additional information is necessary. The illustrations in this manual are for guidance only and may vary in scale, dimensions and model details.